

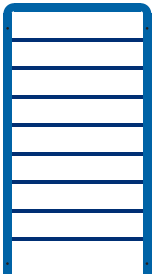

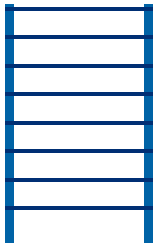

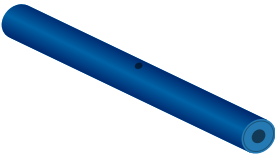

16-Tray Classroom Organizer Cart

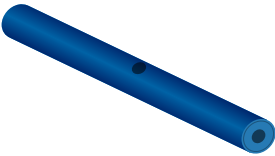
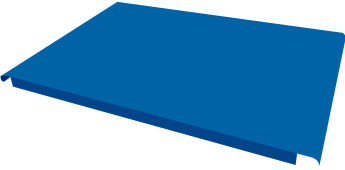

Contents

(2) side frames	(1) middle frame		
			
(2) rods - small holes	(2) rods - large holes	(1) tray	(4) wheels with casters
			
(12) metal washers	(12) rubber washers	(12) hex head bolts	(2) tools: Allen wrench & flat wrench
			

Instructions

**Helpful hints: DO NOT tighten the bolts all the way until the cart is fully assembled.
All shelf openings must face the same direction. Otherwise, the trays will not slide in correctly.**

1) Place a hex head screw through one of the top holes in the side frame. Make sure the head is on the outside of the frame.

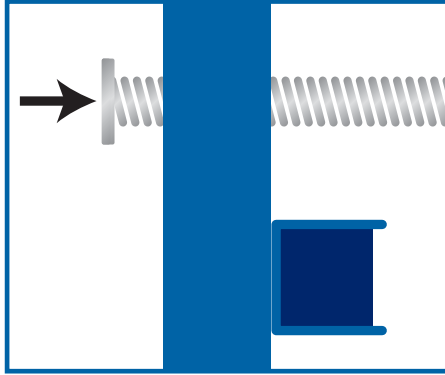

2) Place one rubber washer and one metal washer onto the hex head screw. Make sure the curved side of the rubber washer touches the side frame.

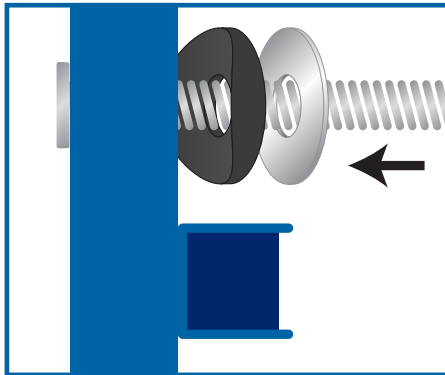

3) Using the Allen wrench, screw on a blue rod with a large hole. The large hole needs to be facing up.

Repeat Steps 1-3 for the other top rod.

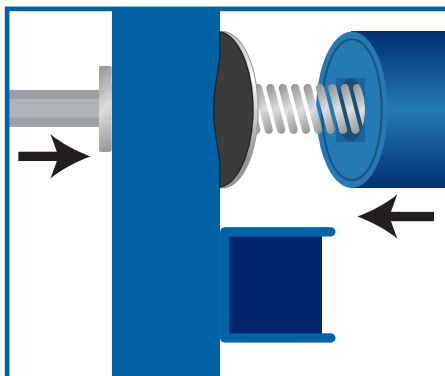

4) Once both top rods are attached, line up the other side frame so it can be fastened.

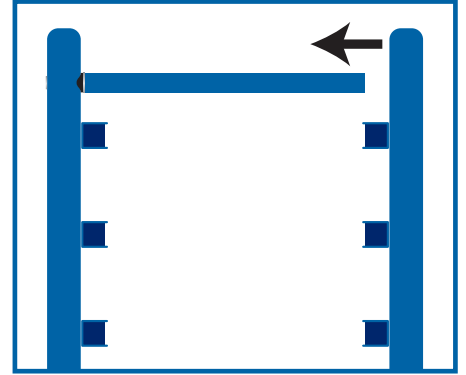

5) Place a hex head screw through the hole in the side frame (similar to Step 1). Thread one rubber washer and one metal washer onto the screw (similar to Step 2).

Repeat for the other top rod.

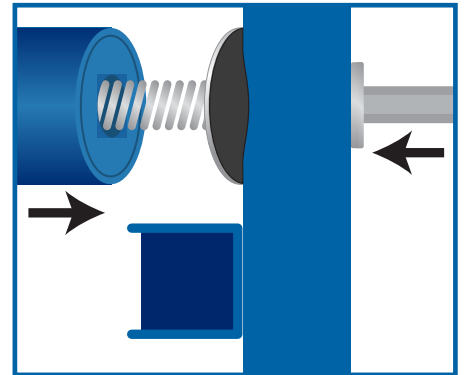

6) The middle frame can now be screwed into the top rods.

Make sure the shelf openings are facing the same direction.

The longer legs of the middle frame must be on the bottom.

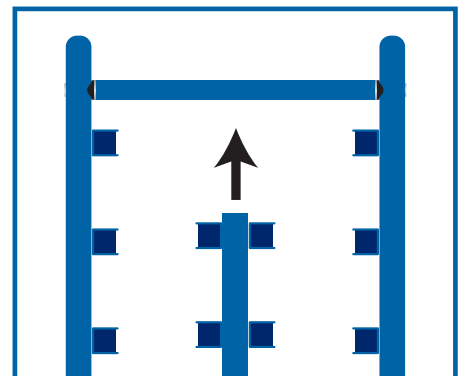

Instructions

Helpful hint: DO NOT tighten the bolts all the way until the cart is fully assembled.

7) Place one rubber washer and one metal washer onto the hex head screw. Make sure the curved side of the rubber washer touches the top rod. Screw together. Repeat for the back.

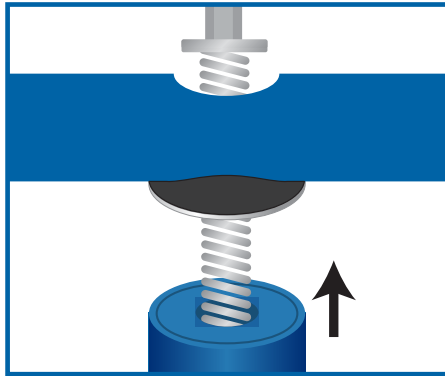

Make sure the large hole on the top rod is facing up.

8) Place one rubber washer and one metal washer onto the hex head screw. Make sure the curved side of the rubber washer touches the side frame.

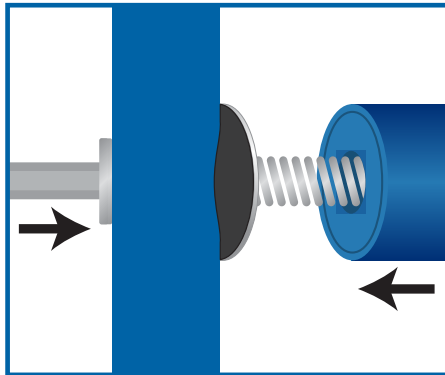

Lightly screw on the bottom blue rod. Repeat for the back.

9) Place one rubber washer and one metal washer between the middle frame and the bottom rod. Make sure the curved side of the rubber washer points down, onto the bottom rod.

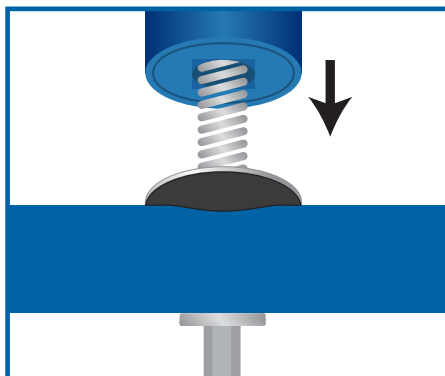

Lightly screw together. Repeat for the back.

10) Place one rubber washer and one metal washer between the bottom rod and side frame. Make sure the curved side of the rubber washer touches the side frame. Screw together. Repeat for the back.

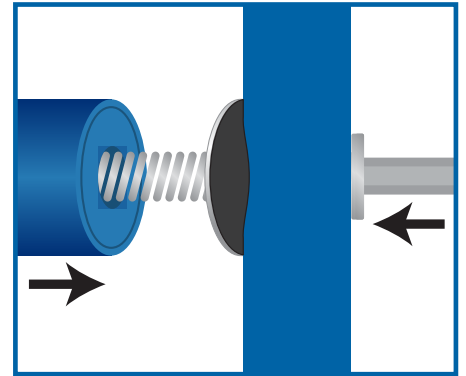

11) Using the included flat wrench, screw the wheels and casters to the bottom of the side frames.

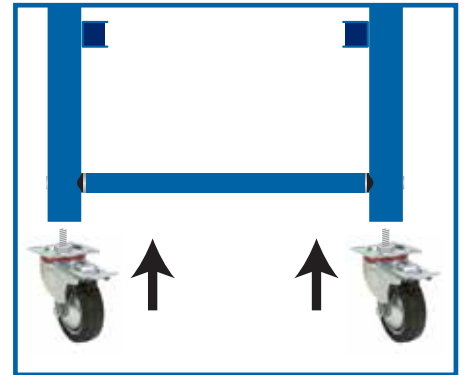

12) All screws can now be fully tightened. Place the tray on the top rods.

Use foam tape underneath if the tray is uneven.

